



# GNI-ANLASS

Komplexität reduzieren |  
Durch Erleben und Kollaboration



# Swiss Center for Design and Health

□ GEBÄUDE NETZWERK INITIATIVE

○ 3. SEPTEMBER 2025

# PUBLIC-PRIVATE-PARTNERSHIP

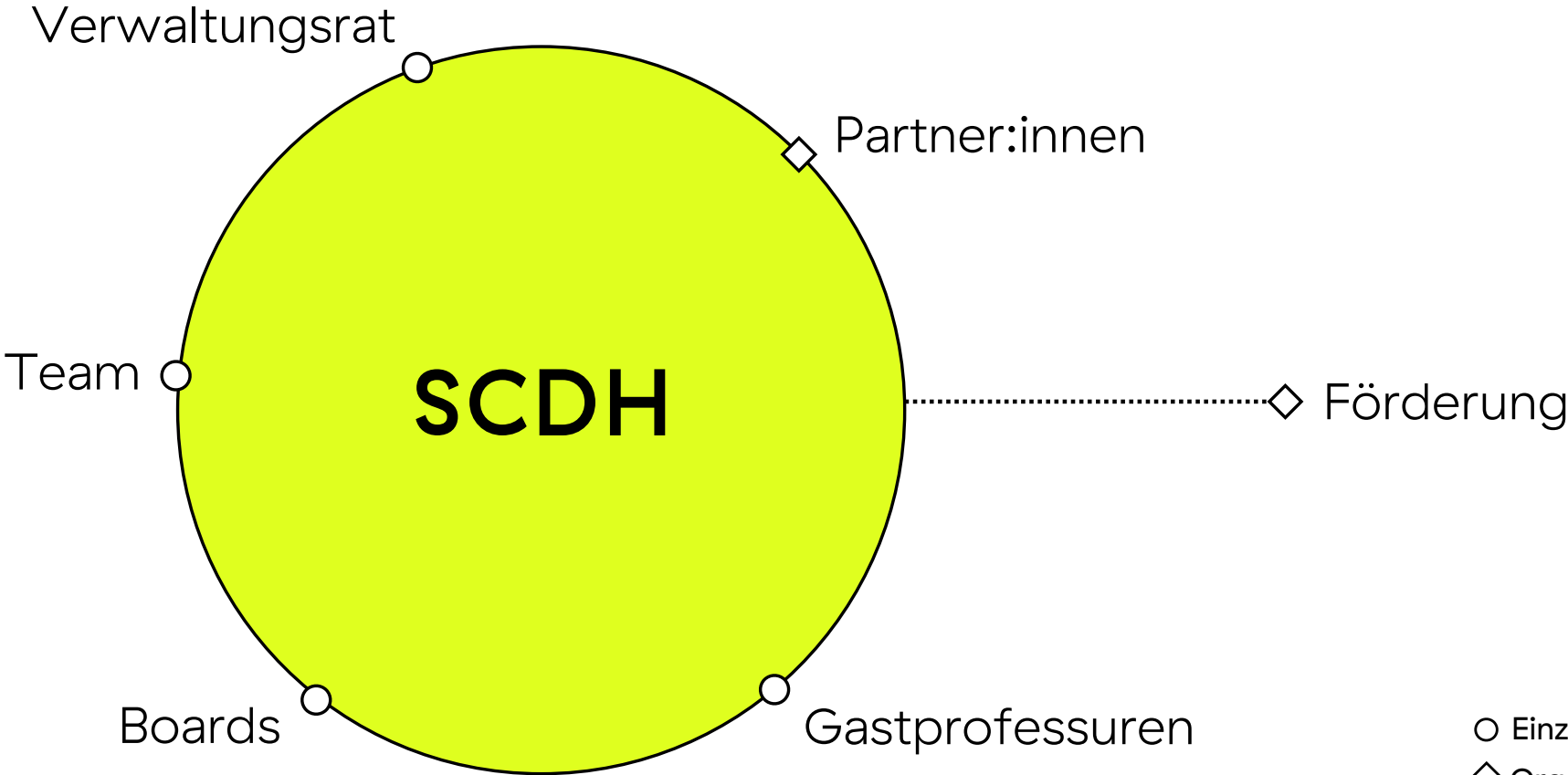

«Alle Menschen sollen in einem Umfeld leben, das ihre Gesundheit unterstützt.»



# TÄTIGKEITSFELDER

## Visuelle Kommunikation

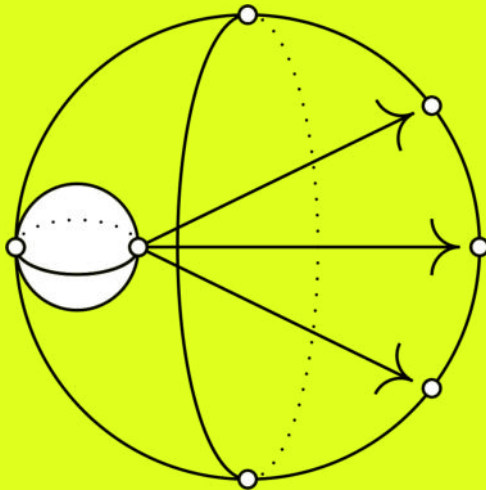

- Signaletik, Leitsysteme
- Informationsdesign
- ◇ Interaction Design

## Objekte & Umwelt

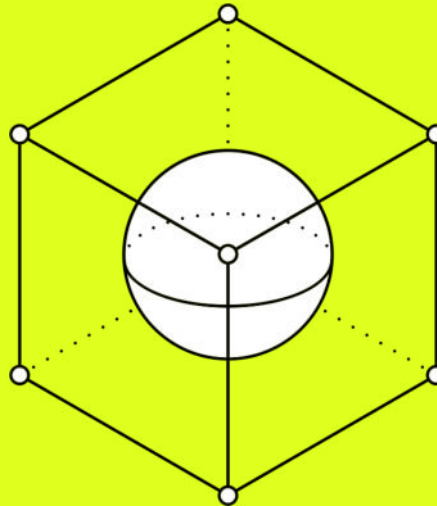

- Architektur, Innenarchitektur
- Stadtplanung, öffentl. Raum
- ◇ Produktdesign

## Systeme & Prozesse

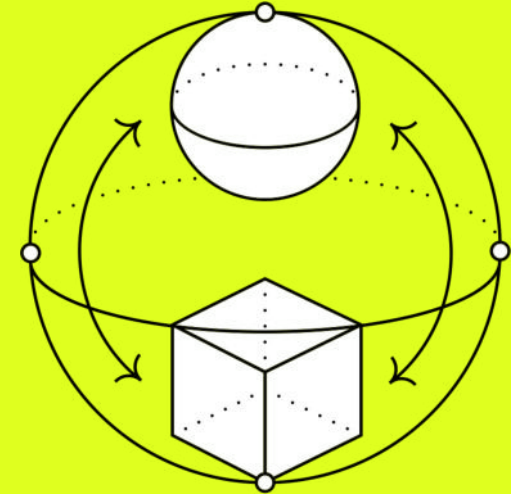

- Service Design
- Organisationsdesign

# EIN HOLISTISCHES ANSATZ

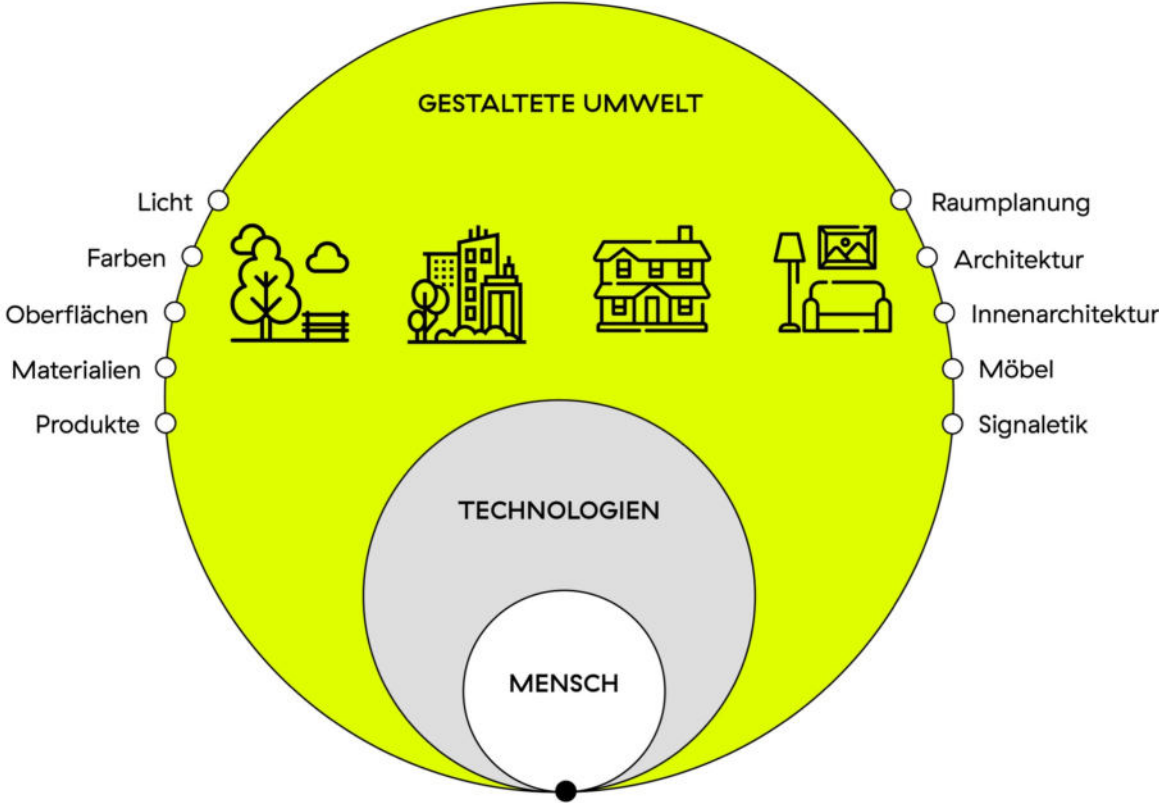

# VORGEHEN

Menschenzentriert

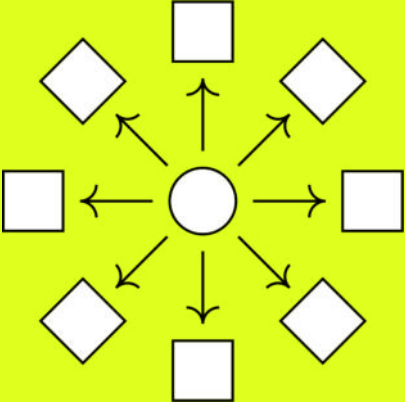

Evidenzbasiert

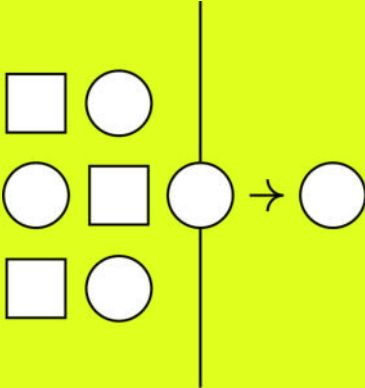

Partizipativ

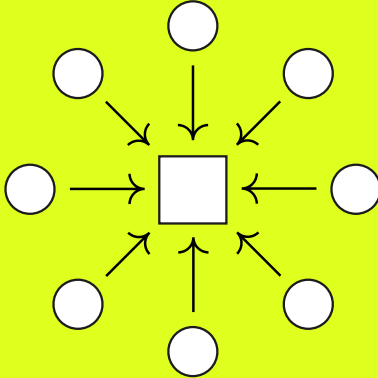

Iterativ

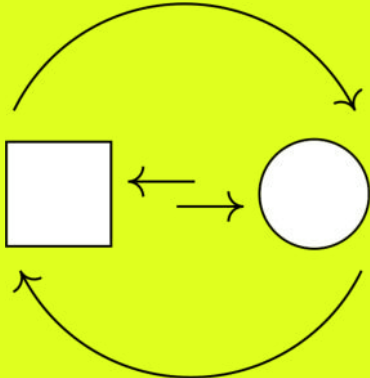







# GRUNDLAGEN EVIDENZBASIERTES DESIGN



Adaptiert von: Agency for Health Design  
(colman et al. 2020, Joseph et al. 2012 CHD 2015)

70 80 90 100

**Demenz**  
keine mittel ausgeprägt

**Mobilität**  
mobil eingeschränkt bettlägerig

**Benötigte Hilfsmittel**  
Gehstock Hörgerät Brille

**Beschreibung + Eigenschaften**

**Wünsche + Motivationen**

**Ängste + Herausforderungen**

**Zitat**

Alter 60 70 80 90 100

**Demenz**  
keine mittel ausgeprägt

**Mobilität**  
mobil eingeschränkt bettlägerig

**Benötigte Hilfsmittel**  
Brille Rollator Rollstuhl

**Beschreibung + Eigenschaften**

**Wünsche + Motivationen**

**Ängste + Herausforderungen**

**Zitat**







# PLATTFORMEN

## Living Lab

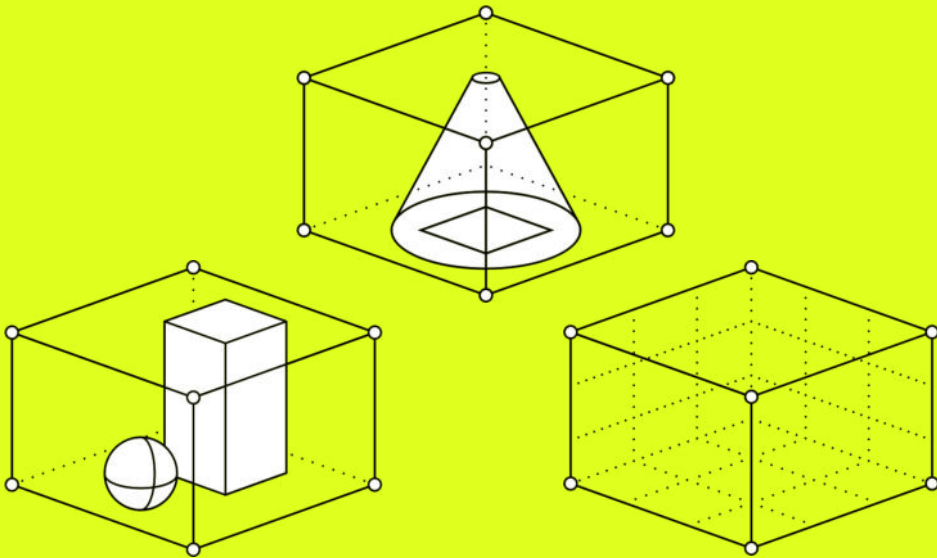

- Extended-Reality-Simulationsfläche
- Realitätsnahe Testräume
- Testanlagen

SCDH.CH

## Werkstätten

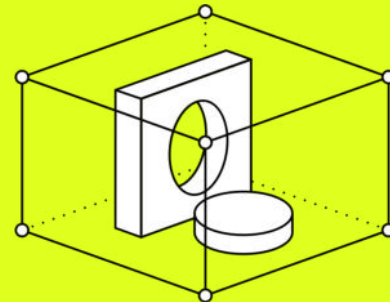

## Material-Kollektion

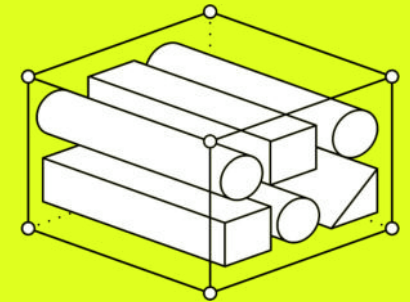

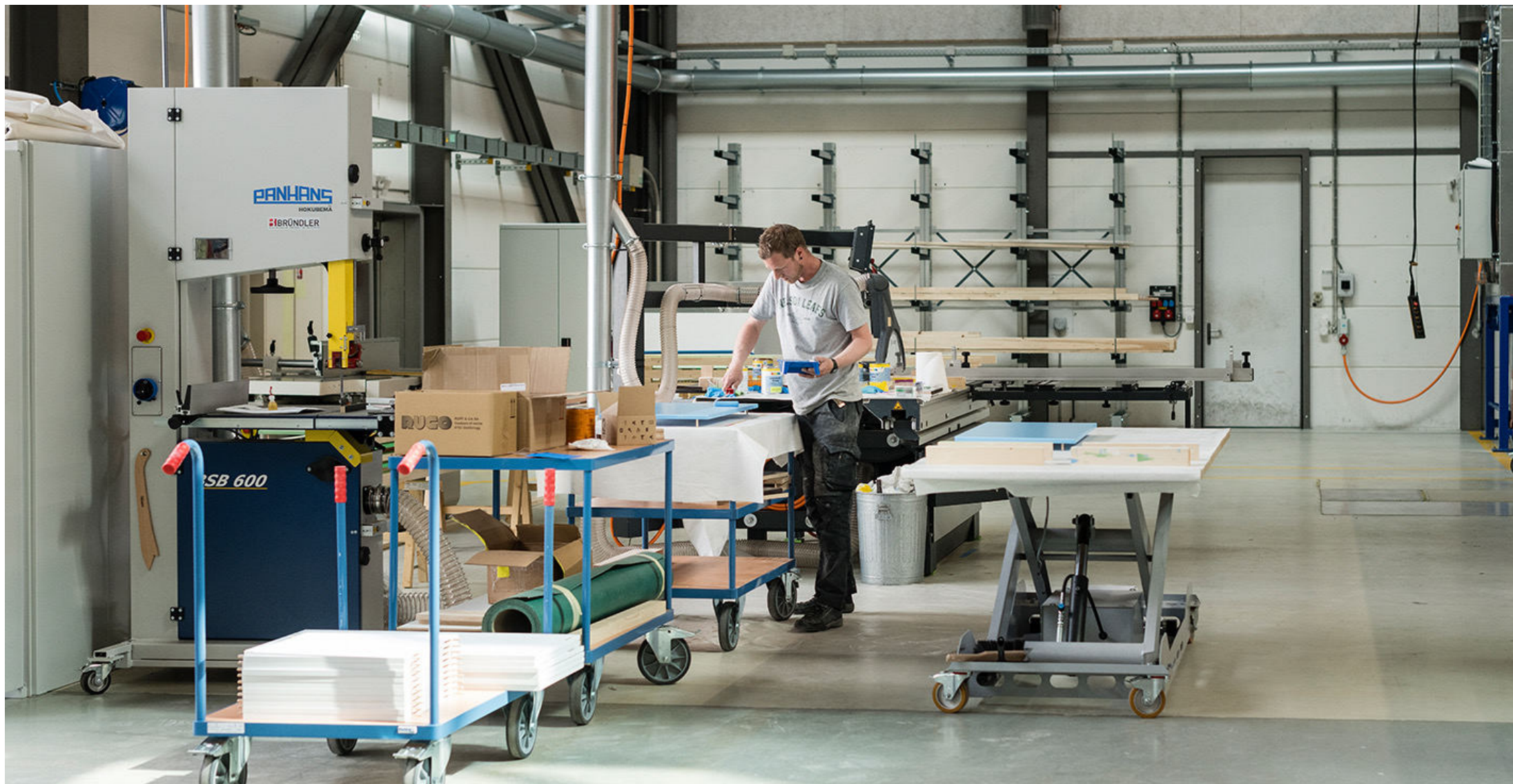



## SITZBANK FÜR ÄLTERE

Entwicklung eines Prototyps für eine alterssensible Sitzmöglichkeit

- Dienstleistung
- Gemeinde Muri-Gümligen bei Bern



→ PROTOTYP

18

## STIFTUNG DESSAULES

Entwicklung eines Gestaltungskonzeptes für eine neue Pflegewohnung

- Dienstleistung
- Stiftung Dessaulles Biel/Bienne

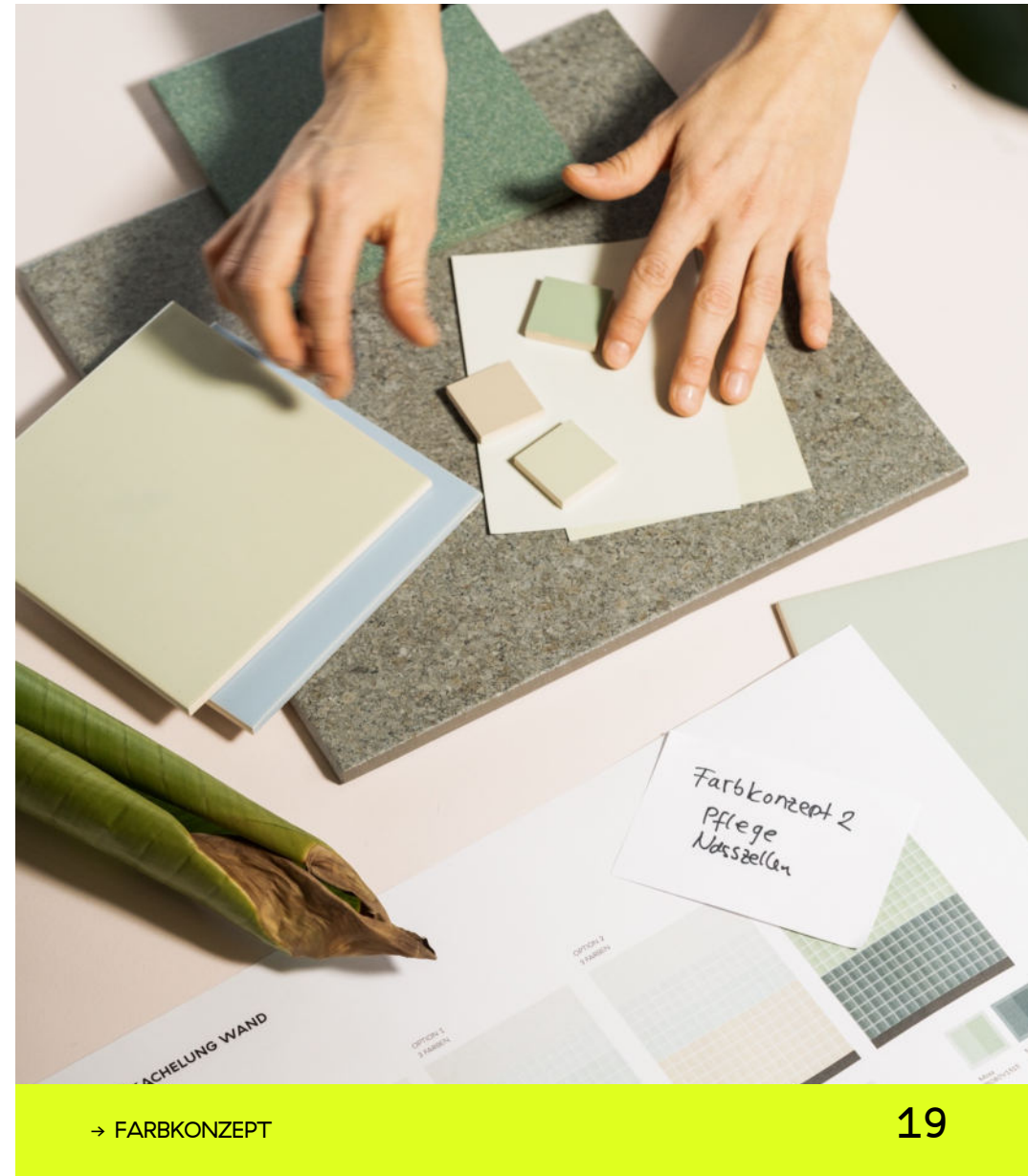







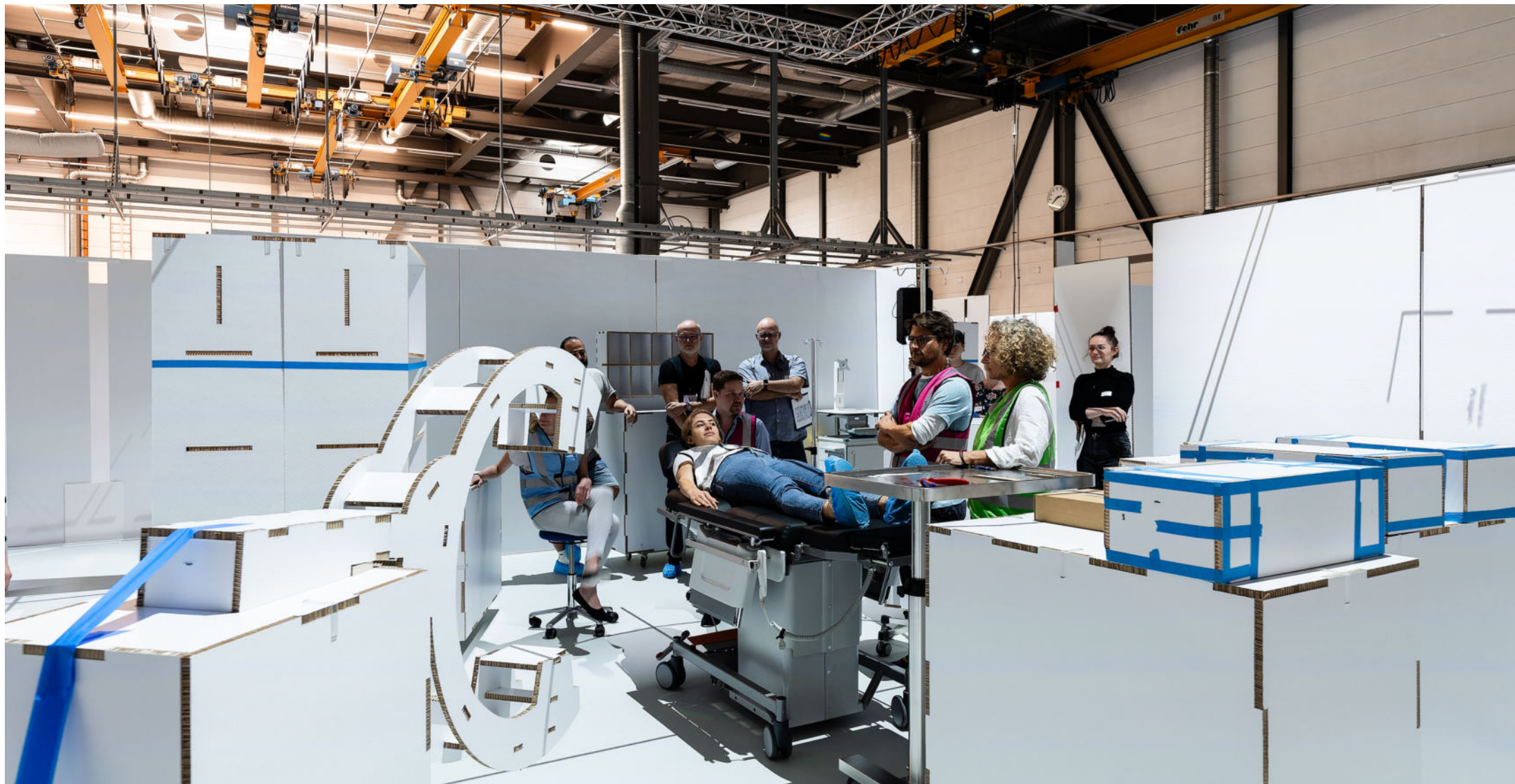

## GENOLIER INNOVATION HUB

Überprüfung eines Operationsblockes im Rohbau

- Dienstleistung
- Genolier Innovation Hub









→ OP-TESTRAUM



→ OP-TESTRAUM

## □ GRUPPEN / MINI WORKSHOPS

---

ROT                      SIMULATIONSFLÄCHE

---

GRAU                    REALITÄTSNAHE TESTRÄUME

---

GELB                    WERKSTÄTTEN  
MATERIAL-KOLLEKTION

---

SCHWARZ    OP-TESTRAUM

---



Danke für Ihre  
Aufmerksamkeit